

NSLAB

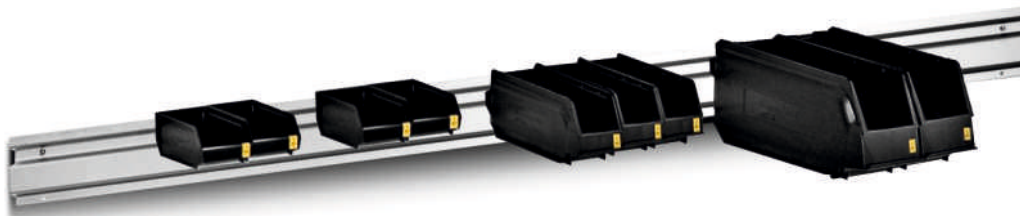

2x

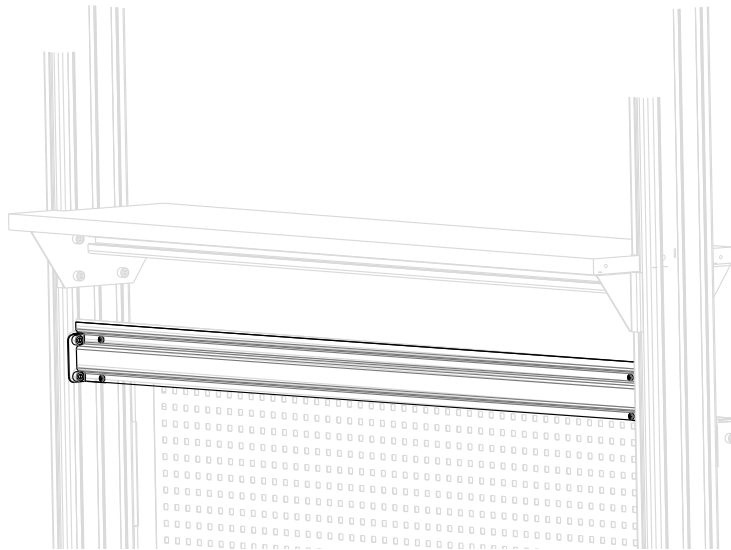
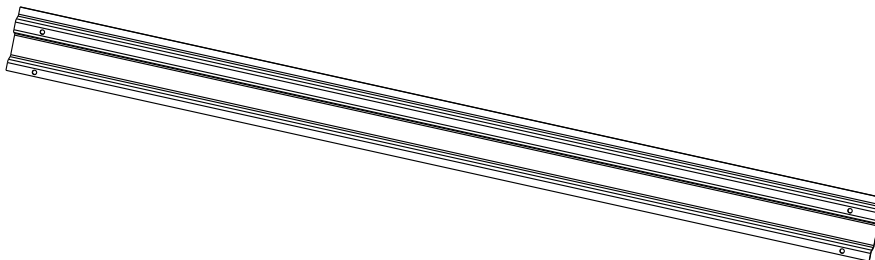

NS.11.29.XX.01

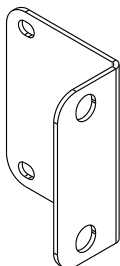

4x

NS.12.6.XX.00.01

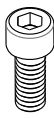

NS.11.42.69.46.00.05.ZP	4x	
NS.1.1.912.10x16	8x	
NS.1.2.7985.6x10	8x	
NS.1.5.934.6	8x	

1

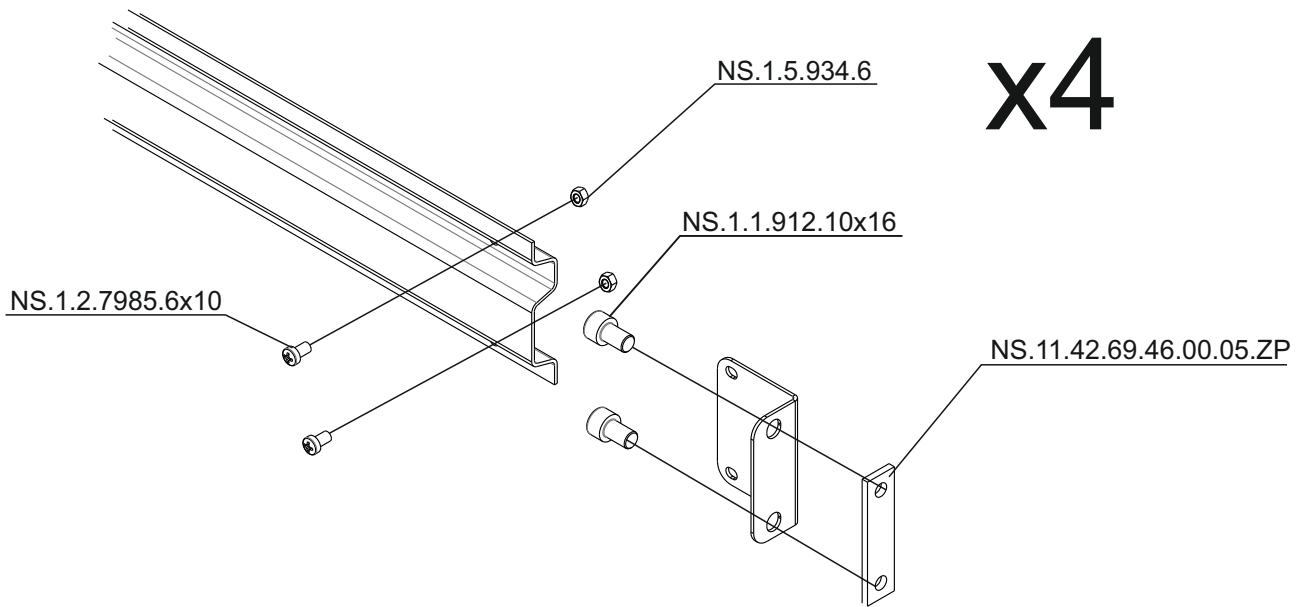

2

